

1

2

3

4

5

6

A

A

B

B

C

C

D

D

E

E

F

F

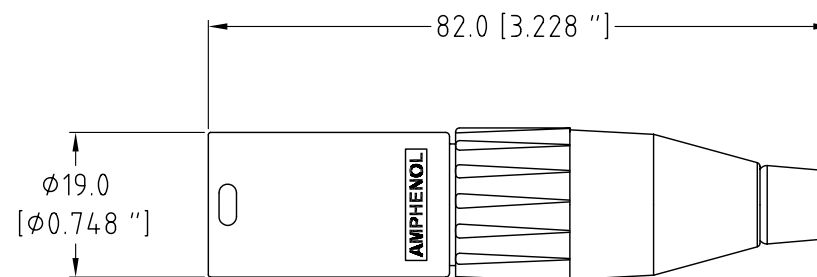

ACTUAL SIZE

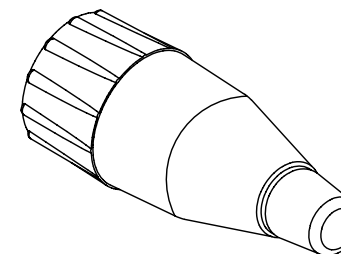
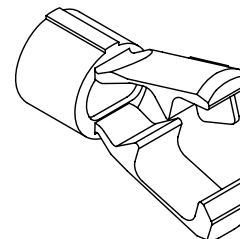
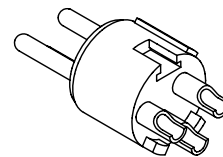
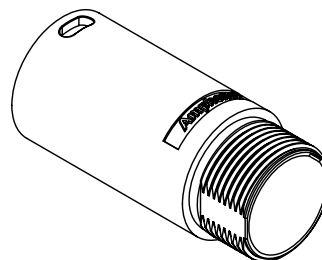

CAT P/No.	SHELL FINISH	CONTACT FINISH
AC3M-AU	NICKEL	GOLD PLATING
AC3MJ-AU		STAMPED
AC3M		SILVER PLATING
AC3MJ		STAMPED
AC3MM-AU	NICKEL	GOLD PLATING
AC3MMJ-AU		MACHINED
AC3MM		SILVER PLATING
AC3MMJ		MACHINED
AC3MB-AU	BLACK	GOLD PLATING
AC3MBJ-AU		STAMPED
AC3MB		SILVER PLATING
AC3MBJ		STAMPED
AC3MMB-AU	BLACK	GOLD PLATING
AC3MMBJ-AU		MACHINED
AC3MMB		SILVER PLATING
AC3MMBJ		MACHINED

UNLESS OTHERWISE SPECIFIED TOLERANCE TO BE		THIS DOCUMENT IS THE PROPERTY OF AMPHENOL AUSTRALIA PTY. LTD. NO PART THEREOF MAY BE REPRODUCED AND USED WITHOUT THE PRIOR WRITTEN CONSENT OF THE OWNER				0	FIRST ISSUE	L.V	01-05-06	----					
LINEAR		ANGULAR		CAD FILE:	00847100	DRN:	L.V	DATE:	01-05-06	REV.	CHANGE DETAILS	BY	DATE	CHG/No	
X ± 0.5	X° ± 1°			MATL:	REFER TO COMPONENT	CKD:	M.N.H	DATE:	01-05-06	TITLE:		AC3M/AC3MM LINE CONNECTOR CUSTOMER DWG			
XX ± 0.1	X°X' ± 30'			DO NOT SCALE	FINISH:	REFER TO COMPONENT	APP'D:	P.M	DATE:	01-05-06	DRAWING NO.		130153-0000		
XX ± 0.05	X°X'X" ± 15"			DIMENSIONS IN MILLIMETRES		THIRD ANGLE PROJECTION	SCALE:	1:1 UOS	PART No:	REFER TO CHART	SIZE:	A4	SHEET 2 OF 2		

1

2

3

4

5

6

1

2

3

4

5

6

A

A

B

B

C

C

D

D

E

E

F

F

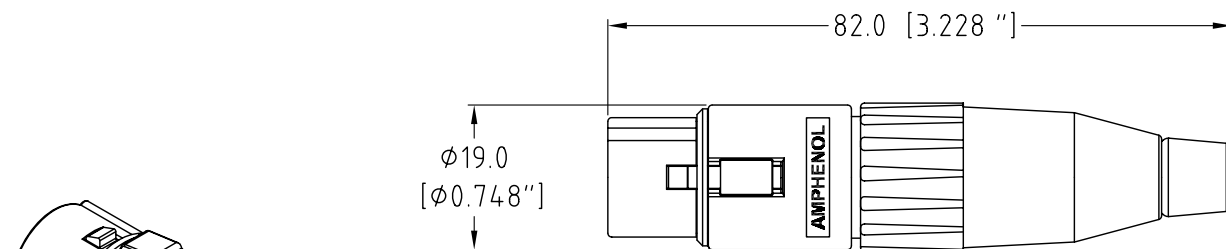

ACTUAL SIZE

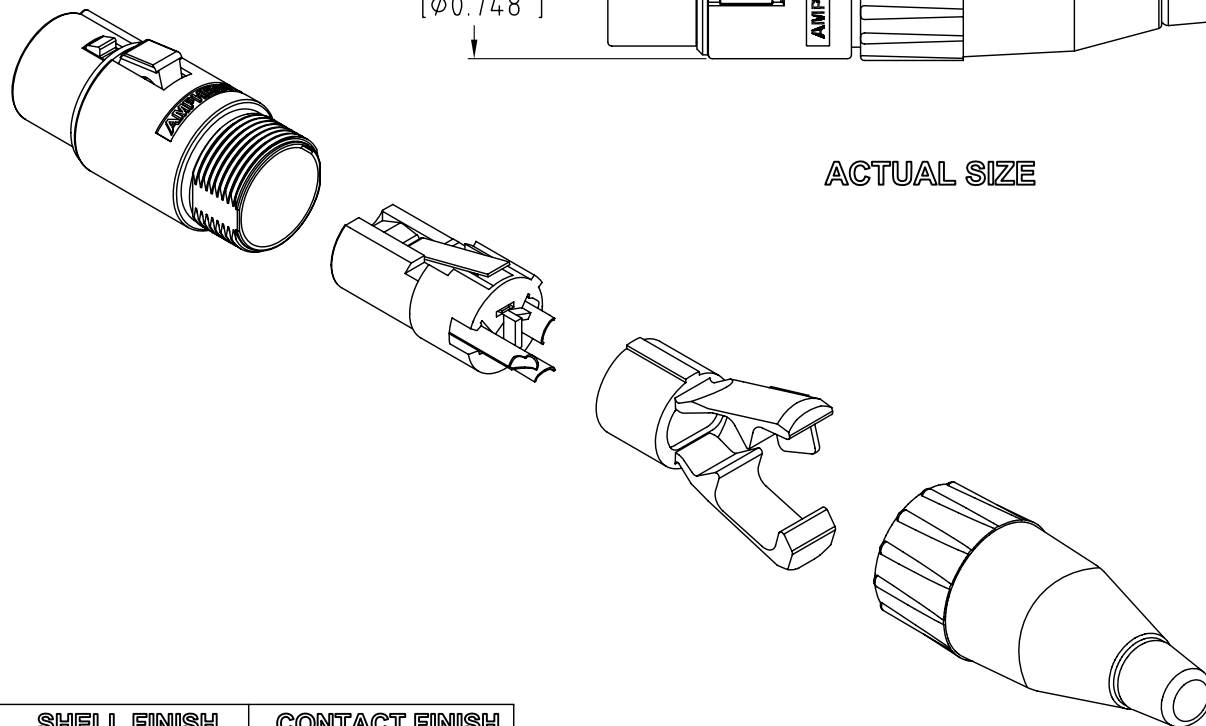

CAT P/No.	SHELL FINISH	CONTACT FINISH
AC3F	NICKEL	TIN PLATING
AC3FJ		GOLD PLATING
AC3F-AU		
AC3FJ-AU	BLACK	TIN PLATING
AC3FB		GOLD PLATING
AC3FBJ		
AC3FB-AU		
AC3FBJ-AU		

UNLESS OTHERWISE SPECIFIED TOLERANCE TO BE		THIS DOCUMENT IS THE PROPERTY OF AMPHENOL AUSTRALIA PTY. LTD. NO PART THEREOF MAY BE REPRODUCED AND USED WITHOUT THE PRIOR WRITTEN CONSENT OF THE OWNER				0	FIRST ISSUE	L.V	01-05-06	----					
LINEAR		ANGULAR		CAD FILE:	00848100	DRN:	L.V	DATE:	01-05-06	TITLE:					
X ± 0.5	X° ± 1°			MATL:	REFER TO COMPONENT	CKD:	M.N.H	DATE:	01-05-06	AC3F LINE CONNECTOR CUSTOMER DWG					
XX ± 0.1	X°X' ± 30'			DO NOT SCALE	FINISH: REFER TO COMPONENT	APP'D:	P.M	DATE:	01-05-06						
XXX ± 0.05	X°X'X" ± 15'			DIMENSIONS IN MILLIMETRES		THIRD ANGLE PROJECTION	SCALE:	1:1 UOS	PART No:	REFER TO CHART	SIZE:	A4	128321-0000	2 OF 2	
BREAK ALL SHARP EDGES AND REMOVE ALL BURRS										Amphenol		Amphenol Australia Pty.Ltd, 2 Fireways Blvd, Keysborough, Vic3173		DRAWING NO. SHEET	